

**RUCIKA**

*Dimana air mengalir sampai jauh*

[www.pipalaku.com](http://www.pipalaku.com)



# PANDUAN TEKNIK & KATALOG PRODUK



**RUCIKA**

**SAFE & LOK**



Aplikasi Pipa Air Minum  
Standar Nasional Indonesia



Pendahuluan	01
Keunggulan & Manfaat	02
Material Properties	03
Aplikasi Sistem	03
Standar Kualitas	03
Jenjang Produk	05
Rucikasafe	07
Rucikalok	13
Transportasi dan Penyimpanan	20
Proses Penyambungan	22
Chemical Resistance	23
Referensi Proyek	32

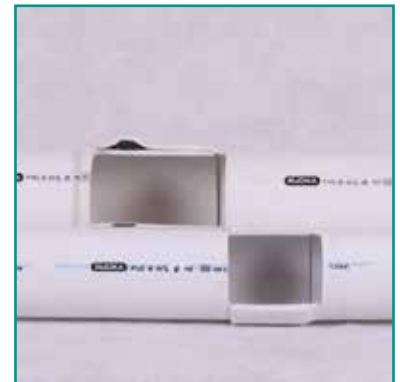
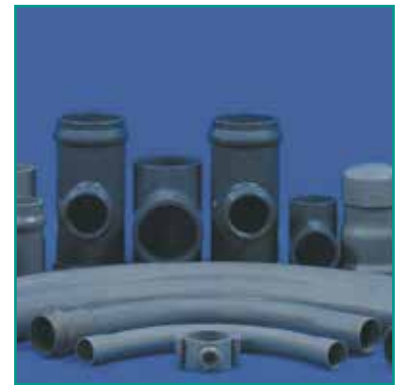

# RUCIKASAFE & RUCIKALOK

## PT WAHANA DUTA JAYA RUCIKA

PT. Wahana Duta Jaya Rucika sebelumnya bernama PT Wavin Duta Jaya, telah memulai usahanya sejak tahun 1973. Dengan pengalaman lebih dari 40 tahun, kami telah memproduksi berbagai jenis Sistem Perpipaan Plastik dengan segala keunggulannya berbahan dasar PVC, PVC-O, PP-R, PE, Astolan seperti PVC Standard, PVC SNI Lite, PVC SNI Safe & Lok, PVC Rucika Standard JIS, PVC – O Exoplas, PE Black, PP-R Rucika Green, SiTech+, Sambungan PVC Rucika (JIS) dan Lem Pipa PVC Ruglue. Di samping itu, adopsi teknologi yang kami lakukan secara berkesinambungan juga menghasilkan beberapa produk inovatif seperti Aquacell, Quickstream, Viny-Core dan Access Fitting. Dengan varian sistem perpipaan terlengkap, menjadikan kami, PT. Wahana Duta Jaya Rucika merupakan salah satu perusahaan pipa plastik yang terlengkap dan terinovatif di Indonesia.

**RUCIKASAFE & RUCIKALOK** adalah sistem jaringan perpipaan uPVC sesuai Standar Nasional Indonesia (SNI) yang dirancang untuk mendistribusikan air minum dan air bersih ke masyarakat luas serta berbagai jenis proyek.

**RUCIKASAFE** menggunakan sistem penyambungan dengan lem atau umum disebut *Solvent Cement (SC)*.

**RUCIKALOK** menggunakan sistem penyambungan dengan ring karet Z-Joint (*Rubber Ring Z-Joint*).

## Keunggulan dan Manfaat

- Kuat dan tidak mudah pecah karena mengandung resin uPVC murni minimal 92,5% dan aditif.
- Aman digunakan untuk mengaliri air minum.
- Tahan terhadap kontaminasi bahan kimia (*chemical resistance* terlampir).
- Mudah dalam transportasi dan penanganan karena ringan.
- Pemasangannya mudah dan cepat.
- Permukaan dalamnya halus sehingga mengurangi *friction losses*.
- Tidak berkarat dan bebas pemeliharaan.

## RUCIKASAFE

Sistem penyambungan RUCIKASAFE menggunakan Sistem *Solvent Cement* (SC) yang menyatukan spigot dan socket dalam sambungan senyawa dengan lem RUGlue. Sambungan senyawa ini menciptakan sistem sambungan yang anti bocor. Sistem *Solvent Cement* (SC) dapat disambungkan dengan menggunakan fitting atau tanpa fitting yang disesuaikan dengan kebutuhan, sehingga pemasangan sistem RUCIKASAFE relatif lebih efisien dan ekonomis.

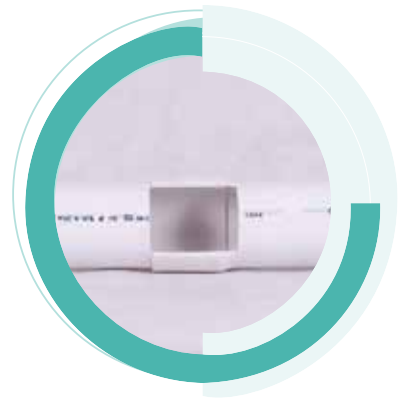

## RUCIKALOK

Sistem penyambungan RUCIKALOK menggunakan Sistem karet Z-Joint (*Rubber Ring Z-Joint*) yang menyatu dengan pipa dan fitting sehingga menciptakan sistem yang anti bocor. *Rubber Ring Z-Joint* memudahkan proses penyambungan pipa dan fitting, karena hanya menggunakan *lubricant* dalam proses penyambungannya, sehingga pemasangan sistem RUCIKALOK relatif lebih efisien dan ekonomis.



## Material Properties

Property	Unit	Value
Specific gravity	g/cm <sup>3</sup>	1,40
Coefficient of linear expansion	mm/m.°C	8 x 10 <sup>-2</sup>
Thermal conductivity	W/m.°C	0,15
Modulus of elasticity	N/mm <sup>2</sup>	3000
Surface resistance	Ohm	> 10 <sup>12</sup>
Tensile strength	N/mm <sup>2</sup>	50-80
Elongation @ break	%	20-40

## Aplikasi Sistem

**RUCIKASAFE** dan **RUCIKALOK** selama ini telah digunakan pada proyek-proyek air minum dan air bersih baik oleh instansi pemerintahan maupun swasta, seperti :

- PDAM
- Real estate
- Industri
- Perkebunan/pertanian
- dan lain-lain

## Standar Kualitas

### Standar Produksi

- ISO 4422-1996 : Pipes and Fittings made of unplasticized Polyvinyl Chloride (uPVC) for Water Supply.
- SNI 06-0084-2002 : Pipa PVC untuk saluran air minum.
- SNI 06-0135-1987 : Sambungan pipa PVC untuk air minum.

## Standar Pengujian

- SNI 06-2544-1991 : Uji ketahanan PVC terhadap metilene klorida
- SNI 06-2548-1991 : Uji diameter luar pipa PVC dengan jangka sorong
- SNI 06-2549-1991 : Uji kekuatan PVC terhadap tekanan hidrostatis
- SNI 06-2550-1991 : Uji ketebalan dinding pipa PVC untuk air minum
- SNI 06-2551-1991 : Uji bentuk dan sifat tampak pipa PVC untuk air minum
- SNI 06-2552-1991 : Pengambilan contoh uji pipa PVC untuk air minum
- SNI 06-2553-1991 : Uji perubahan panjang pipa PVC untuk air minum dengan uji oven
- SNI 06-2555-1991 : Uji kadar PVC pada pipa PVC untuk air minum dengan THF
- SNI 06-2556-1991 : Uji diameter luar pipa PVC untuk air minum dengan pita meter

## Standard Dimensional Ratio (SDR)

*Standard Dimensional Ratio* (SDR) atau yang dikenal sebagai rasio dimensi standar, digunakan untuk menggambarkan hubungan antara diameter pipa, ketebalan dinding dan tekanan nominal pipa. Berikut ini adalah persamaanya:

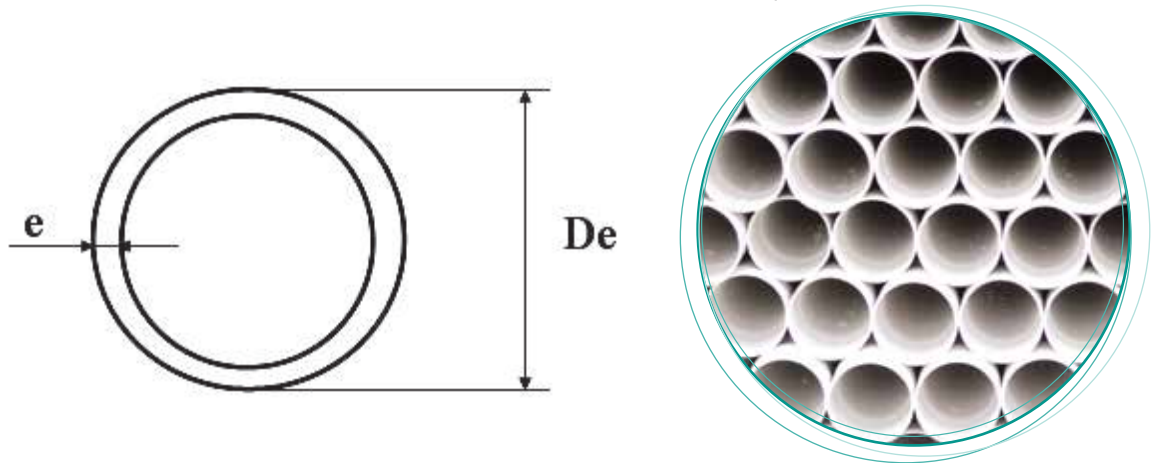

$$S = \frac{\sigma}{PN}$$

dia ≤ 50 mm maka  $\sigma = 100\text{kgf/cm}^2$

dia > 50 mm maka  $\sigma = 125\text{kgf/cm}^2$

$$\text{SDR} = 2S + 1$$

$$\text{SDR} = \frac{De}{e}$$

De	= Diameter luar.
e	= Tebal dinding.
PN	= Tekanan nominal pipa.
SDR	= Rasio Dimensi Standar Pipa.
S	= Seri pipa.

## Panjang Efektif

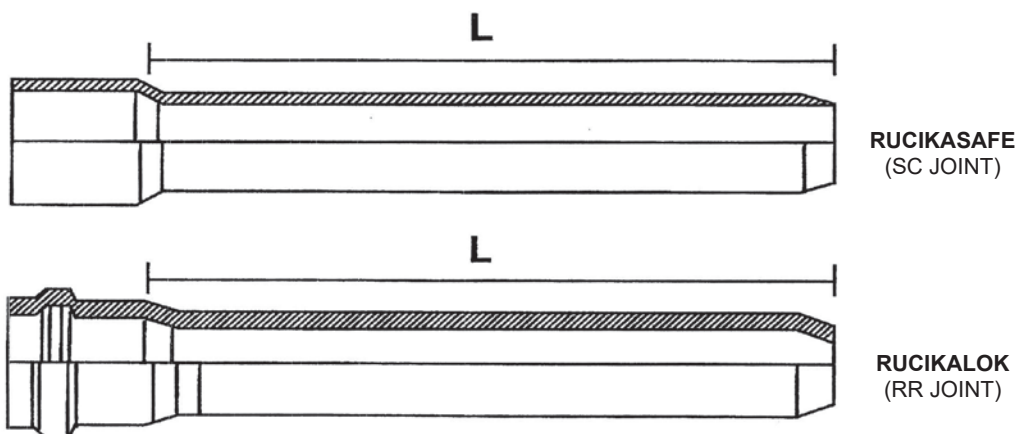

L = Panjang Effective

## Jenang Produk

Panjang Efektif	4 meter				6 meter												
	Nominal Diameter (mm)	20	25	32	40	50	63	90	110	160	200	250	315	355	400	500	630
Joint																	
RUCIKASAFE	NP 1,6 MPa (S. 6,3)																
			NP 1,25 MPa (S.8)														
				NP 1,0 MPa (S.10)													
						NP 0,8 MPa (S. 12,5)											
									NP 0,8 MPa (S. 16)								
RUCIKALOK									NP 1,6 MPa (S. 8)								
										NP 1,6 MPa (S. 10)							
											NP 1,0 MPa (S. 12,5)						
												NP 0,8 MPa (S. 16)					



**SOLVENT CEMENT PIPE  
PIPA DENGAN SISTEM SAMBUNGAN SC**

<b>TEKANAN NOMINAL</b>	<b>DIAMETER LUAR (mm)</b>	<b>TEBAL DINDING (mm)</b>	<b>PANJANG EFEKTIF (m)</b>	<b>KODE PRODUK</b>
1,6 MPa (16 bar) S.6,3	20	1,5	4	000 020 101
1,25 Mpa (12,5 bar) S.8	25	1,5	4	010 025 101
	32	1,9	4	010 032 101
	40	2,4	4	010 040 101
1,00 MPa (10 bar) S.10	32	1,6	4	020 032 101
	40	1,9	4	020 040 101
	50	2,4	6	020 050 201
1,25 MPa (12,5 bar) S.12,5	63	3,0	6	010 063 201
	90	4,3	6	010 090 201
	110	5,3	6	010 110 201
	160	7,7	6	010 160 201
1,00 MPa (10 bar) S.12,5	63	2,4	6	020 063 201
	90	3,5	6	020 090 201
	110	4,2	6	020 110 201
	160	6,2	6	020 160 201
0,8 MPa (8 bar) S.12,5	50	2,0	6	030 050 201
0,8 MPa (8 bar) S.12,5	63	2,0	6	030 063 201
	90	2,8	6	030 090 201
	110	3,4	6	030 110 201
	160	4,9	6	030 160 201

# RUCIKAS FE

## PVC TEE SC

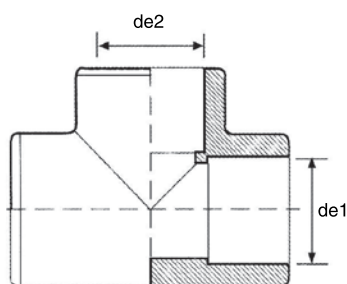
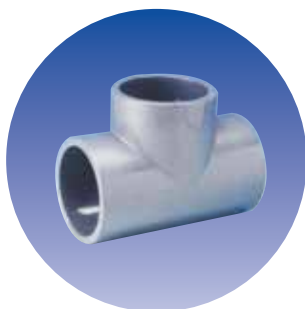

de <sub>1</sub> (mm)		de <sub>2</sub> (mm)	Kode Produk
20	x	20	01 41 00 020 0
25	x	25	01 41 00 025 0
25	x	20	01 41 00 024 1*
32	x	32	01 41 00 032 0
32	x	25	01 41 00 031 1*
32	x	20	01 41 00 030 1*
40	x	40	01 41 00 040 0
40	x	32	01 41 00 039 1*
40	x	25	01 41 00 038 1*
40	x	20	01 41 00 037 1*
50	x	50	01 41 00 050 0
50	x	40	01 41 00 049 1*
50	x	32	01 41 00 048 1*
50	x	25	01 41 00 047 1*
63	x	63	01 41 00 063 5
63	x	50	01 41 00 062 5
63	x	40	01 41 00 061 1*
63	x	32	01 41 00 060 5
63	x	25	01 41 00 059 1*
90	x	90	01 41 00 090 5
90	x	63	01 41 00 088 1*
90	x	50	01 41 00 087 1*
110	x	110	01 41 00 110 5
110	x	90	01 41 00 109 1*
110	x	63	01 41 00 107 1*
160	x	160	01 41 00 160 5
160	x	110	01 41 00 157 1*
160	x	90	01 41 00 156 1*
160	x	63	01 41 00 154 1*

\* = Fitting fabrikasi / hand made

## PVC FAUCET TEE SC

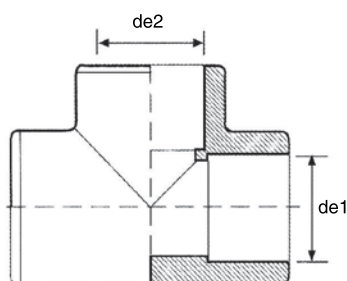
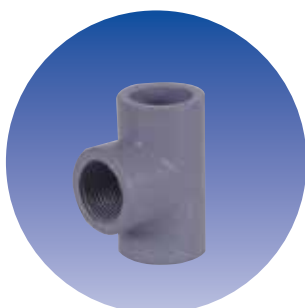

de <sub>1</sub> (mm)		de <sub>2</sub> (inch)	Kode Produk
20	x	1/2"	02 42 04 020 5
25	x	3/4"	02 42 04 024 5

## PVC CLAMP SADDLE

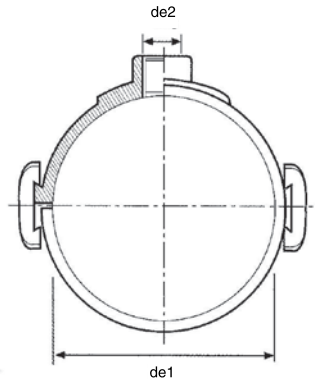

de <sub>1</sub> (mm)		de <sub>2</sub> (inch)	Kode Produk
50	x	1/2"	02 43 31 050 0
50	x	3/4"	02 43 31 049 0
50	x	1"	02 43 31 048 0
50	x	1 1/4"	02 43 31 047 0
63	x	1/2"	02 43 31 063 0
63	x	3/4"	02 43 31 062 0
63	x	1"	02 43 31 061 0
63	x	1 1/4"	02 43 31 060 0
63	x	1 1/2"	02 43 31 059 0
90	x	1/2"	02 43 31 090 0
90	x	3/4"	02 43 31 089 0
90	x	1"	02 43 31 088 0
90	x	1 1/4"	02 43 31 087 0
90	x	1 1/2"	02 43 31 086 0
110	x	1/2"	02 43 31 110 0
110	x	3/4"	02 43 31 109 0
110	x	1"	02 43 31 108 0
110	x	1 1/4"	02 43 31 107 0
110	x	1 1/2"	02 43 31 106 0
160	x	1/2"	02 43 31 160 0
160	x	3/4"	02 43 31 159 0
160	x	1"	02 43 31 158 0
160	x	3/4"	02 43 31 157 0
160	x	1 1/2"	02 43 31 156 0
160	x	2"	02 43 31 155 0
200	x	1/2"	02 43 31 200 0
200	x	3/4"	02 43 31 199 0
200	x	1"	02 43 31 198 0
200	x	1 1/4"	02 43 31 197 0
200	x	1 1/2"	02 43 31 196 0
200	x	2"	02 43 31 195 0
25	x	1 1/4"	02 43 31 247 5
315	x	1 1/4"	02 43 31 312 5

## PVC INSERT REDUCER (LONG)

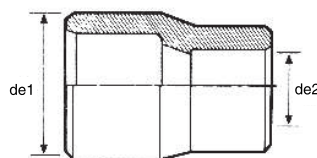
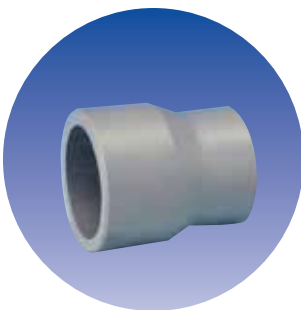

de <sub>1</sub> (mm)		de <sub>2</sub> (mm)	Kode Produk
40	x	20	01 21 04 038 0
50	x	25	01 21 04 048 0
63	x	32	01 21 04 061 0

## PVC INSERT REDUCER (SHORT)

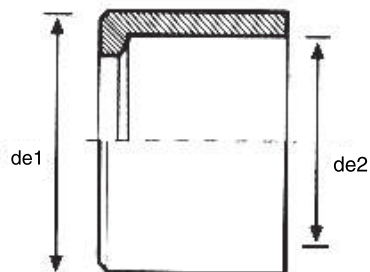
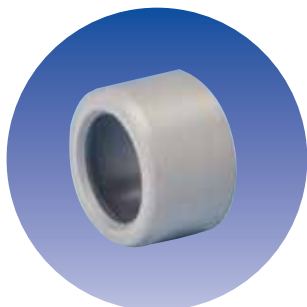

de <sub>1</sub> (mm)	x	de <sub>2</sub> (mm)	Kode Produk
25	x	20	01 21 03 025 0
32	x	25	01 21 03 032 0
32	x	20	01 21 03 031 0
40	x	32	01 21 03 040 0
40	x	25	01 21 03 039 0
50	x	40	01 21 03 050 0
50	x	32	01 21 03 049 0
63	x	50	01 21 03 063 0
90	x	63	01 21 03 089 0
110	x	90	01 21 03 110 5
110	x	63	01 21 03 108 5
160	x	110	01 21 03 158 5
160	x	90	01 21 03 157 5

## PVC REDUCER SC

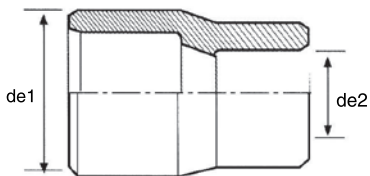
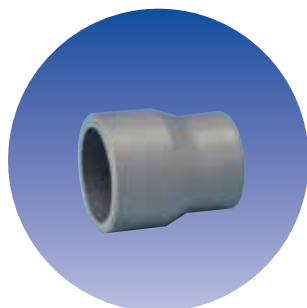

de <sub>1</sub> (mm)	x	de <sub>2</sub> (mm)	Kode Produk
25	x	20	01 21 00 025 0
32	x	25	01 21 00 032 0
32	x	20	01 21 00 031 0
40	x	32	01 21 00 040 0
40	x	25	01 21 00 039 0
50	x	40	01 21 00 050 0
50	x	32	01 21 00 049 0
63	x	50	01 21 00 063 1*
90	x	63	01 21 00 089 1*
90	x	50	01 21 00 088 1*
110	x	90	01 21 00 110 1*
110	x	63	01 21 00 108 1*
160	x	110	01 21 00 158 1*

\* = Fitting fabrikasi / hand made

## PVC CAP SC

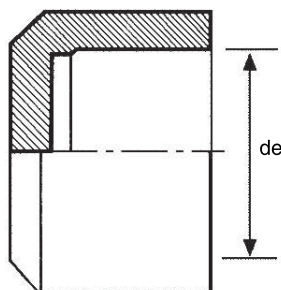
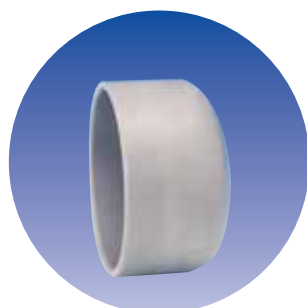

de (mm)	Kode Produk
20	01 500 020 0
25	01 500 025 0
32	01 500 032 0
40	01 500 040 0
50	01 500 050 0
63	01 500 063 1*
90	01 500 090 1*
110	01 500 110 1*
160	01 500 160 1*

\* = Fitting fabrikasi / hand made

## PVC ELBOW SC

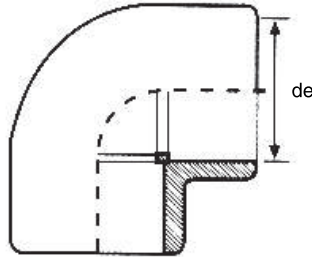
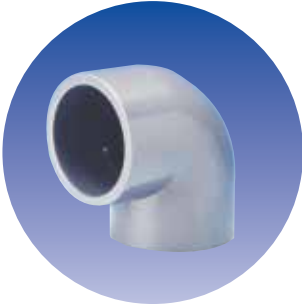

de (mm)	Kode Produk
20	01 300 020 0
25	01 300 025 0
32	01 300 032 0
40	01 300 040 0
50	01 300 050 0
63	01 300 063 5
90	01 300 090 5
110	01 300 110 5
160	01 300 160 5

## PVC SOCKET SC

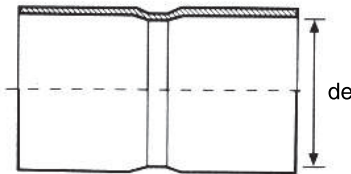
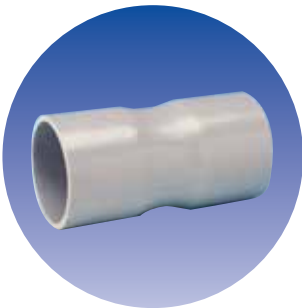

de (mm)	Kode Produk
20	01 11 00 020 1*
25	01 11 00 025 1*
32	01 11 00 032 1*
40	01 11 00 040 1*
50	01 11 00 050 1*
63	01 11 00 063 1*
90	01 11 00 090 1*
110	01 11 00 110 1*
160	01 11 00 160 1*

\* = Fitting fabrikasi / hand made

## PVC FLANGE ADAPTOR

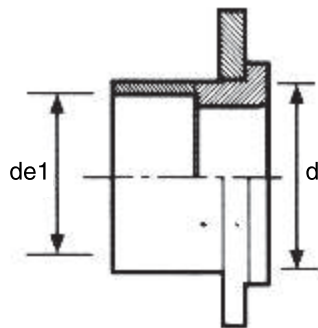
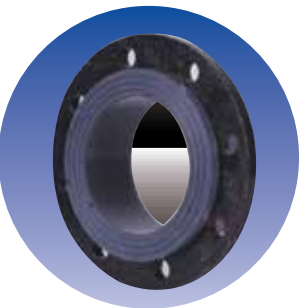

de <sub>1</sub> (mm)		d (DN)	Kode Produk
50	x	40	01 11 12 050 1*
63	x	50	01 11 12 063 1*
90	x	80	01 11 12 090 1*
110	x	100	01 11 12 110 1*
160	x	150	01 11 12 160 1*

\* = Fitting fabrikasi / hand made

## PVC FLANGE SPIGOT

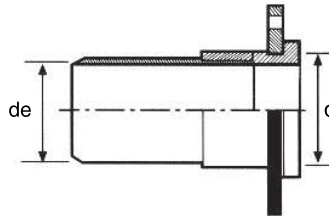
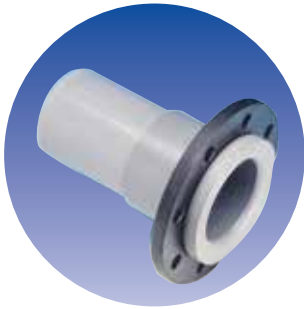

de (mm)	x	d (DN)	Kode Produk
63	x	50	01 11 14 063 1*
90	x	80	01 11 14 090 1*
110	x	100	01 11 14 110 1*
160	x	150	01 11 14 160 1*
200	x	200	01 11 14 200 1*
250	x	250	01 11 14 250 1*
315	x	300	01 11 14 315 1*

\* = Fitting fabrikasi / hand made

## PVC FAUCET ELBOW

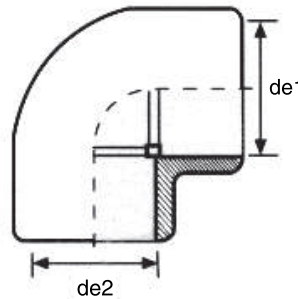
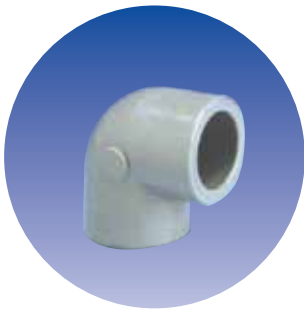

de <sub>1</sub> (mm)	x	de <sub>2</sub> (mm)	Kode Produk
25	x	20	02 31 09 020 5
32	x	25	02 31 09 025 5

## PVC LONG BEND SC (LONG)

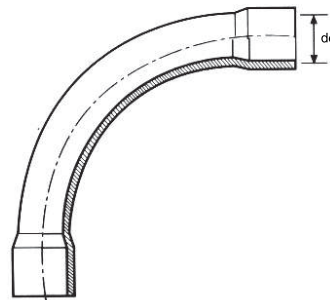

de (mm)	Bend	Kode Produk
63	11°	01 3 04 059 1*
90	11°	01 3 04 086 1*
110	11°	01 3 04 106 1*
150	11°	01 3 04 156 1*
63	22°	01 3 04 060 1*
90	22°	01 3 04 087 1*
110	22°	01 3 04 107 1*
160	22°	01 3 04 056 1*
50	45°	01 3 04 049 1*
63	45°	01 3 04 062 1*
90	45°	01 3 04 089 1*
110	45°	01 3 04 109 1*
160	45°	01 3 04 159 1*
50	90°	01 3 04 050 1*
63	90°	01 3 04 063 1*
90	90°	01 3 04 090 1*
110	90°	01 3 04 110 1*
160	90°	01 3 04 160 1*

\* = Fitting fabrikasi / hand made

## PVC FAUCET SOCKET

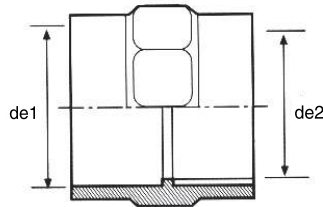

de <sub>1</sub> (mm)	de <sub>2</sub> (inch)	Kode Produk
20	x 1/2"	01 12 11 020 5
25	x 3/4"	01 12 11 024 5
32	x 1"	01 12 11 030 5
40	x 1 1/4"	01 12 11 037 5
50	x 1 1/2"	01 12 11 046 5
63	x 2"	01 12 11 058 5
90	x 3"	01 12 11 083 5
110	x 4"	01 12 11 102 5

## PVC VALVE SOCKET

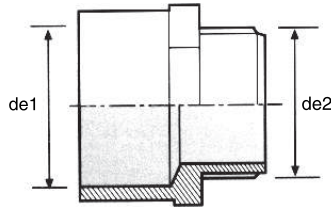

de <sub>1</sub> (mm)	de <sub>2</sub> (inch)	Kode Produk
20	x 1/2"	01 12 10 020 5
25	x 3/4"	01 12 10 024 0
32	x 1"	01 12 10 030 5
40	x 1 1/4"	01 12 10 037 5
50	x 1 1/2"	01 12 10 046 5
63	x 2"	01 12 10 058 5
90	x 3"	01 12 10 083 5
110	x 4"	01 12 10 102 5

## RUBBER RING PIPE SISTEM SAMBUNGAN RRJ/Z-JOINT

TEKANAN NOMINAL	DIAMETER LUAR (mm)	TEBAL DINDING (mm)	PANJANG EFEKTIF (m)	KODE BARANG
1.6 MPa (16 bar) S.8	63	3,8	6	000 063 202
	90	5,4	6	000 090 202
	110	6,6	6	000 110 202
	160	9,5	6	000 160 202
	200	11,9	6	000 200 202
	250	14,8	6	000 250 202
	315	18,7	6	000 315 202
1.25 Mpa (12,5 bar) S.10	63	3,0	6	010 063 202
	90	4,3	6	010 090 202
	110	5,3	6	010 110 202
	160	7,7	6	010 160 202
	200	9,6	6	010 200 202
	250	11,9	6	010 250 202
	315	15,0	6	010 315 202
	400	19,1	6	010 400 202
	500	23,9	6	010 500 202
	630	30,0	6	010 630 202
1.00 MPa (10 bar) S.12,5	63	2,4	6	020 063 202
	90	3,5	6	020 090 202
	110	4,2	6	020 110 202
	160	6,2	6	020 160 202
	200	7,7	6	020 200 202
	250	9,6	6	020 250 202
	315	12,1	6	020 315 202
	400	15,3	6	020 400 202
	500	19,1	6	020 500 202
	630	24,1	6	020 630 202
0.80 MPa (8 bar) S.16	63	2,0	6	030 063 202
	90	2,8	6	030 090 202
	110	3,4	6	030 110 202
	160	4,9	6	030 160 202
	200	6,2	6	030 200 202
	250	7,7	6	030 250 202
	315	9,7	6	030 315 202
	400	12,3	6	030 400 202
	500	15,3	6	030 500 202
	630	19,3	6	030 630 202

## PVC BEND RR (LONG)

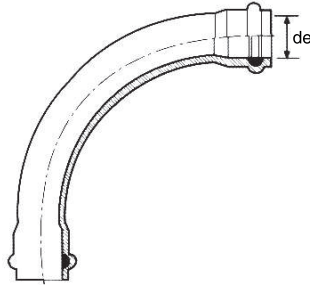

de (mm)	Bend	Kode Produk
63	11°	01 3 06 059 1*
90	11°	01 3 06 086 1*
110	11°	01 3 06 106 1*
160	11°	01 3 06 156 1*
200	11°	01 3 06 196 1*
250	11°	01 3 06 246 1*
315	11°	01 3 06 311 1*
63	22°	01 3 06 060 1*
90	22°	01 3 06 087 1*
110	22°	01 3 06 107 1*
200	22°	01 3 06 197 1*
250	22°	01 3 06 247 1*
315	22°	01 3 06 312 1*
63	22°	01 3 06 062 1*
90	45°	01 3 06 089 1*
110	45°	01 3 06 109 1*
160	45°	01 3 06 159 1*
200	45°	01 3 06 199 1*
250	45°	01 3 06 249 1*
315	45°	01 3 06 314 1*
63	90°	01 3 06 063 1*
90	90°	01 3 06 090 1*
110	90°	01 3 06 110 1*
160	90°	01 3 06 160 1*
200	90°	01 3 06 200 1*
250	90°	01 3 06 250 1*
315	90°	01 3 06 315 1*

\* = Fitting fabrikasi / hand made

## PVC REDUCER RR

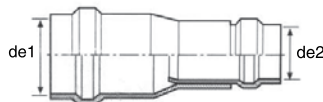

de <sub>1</sub> (mm)		de <sub>2</sub> (mm)	Kode Produk
90	x	63	01 21 01 089 1*
110	x	90	01 21 01 110 1*
110	x	63	01 21 01 108 1*
160	x	110	01 21 01 158 1*
160	x	90	01 21 01 157 1*
200	x	160	01 21 01 199 1*
200	x	110	01 21 01 196 1*
250	x	200	01 21 01 249 1*
250	x	160	01 21 01 247 1*
315	x	250	01 21 01 314 1*
315	x	200	01 21 01 312 1*

\* = Fitting fabrikasi / hand made

## PVC BEND RR/SP (LONG)

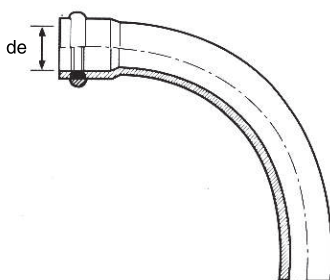

de (mm)	Bend	Kode Produk
63	11°	01 3 05 059 1*
90	11°	01 3 05 086 1*
110	11°	01 3 05 106 1*
160	11°	01 3 05 156 1*
200	11°	01 3 05 196 1*
250	11°	01 3 05 246 1*
315	11°	01 3 05 311 1*
63	22°	01 3 05 060 1*
90	22°	01 3 05 087 1*
110	22°	01 3 05 107 1*
200	22°	01 3 05 197 1*
250	22°	01 3 05 247 1*
315	22°	01 3 05 312 1*
63	22°	01 3 05 062 1*
90	45°	01 3 05 089 1*
110	45°	01 3 05 109 1*
160	45°	01 3 05 159 1*
200	45°	01 3 05 199 1*
250	45°	01 3 05 249 1*
315	45°	01 3 05 314 1*
63	90°	01 3 05 063 1*
90	90°	01 3 05 090 1*
110	90°	01 3 05 110 1*
160	90°	01 3 05 160 1*
200	90°	01 3 05 200 1*
250	90°	01 3 05 250 1*
315	90°	01 3 05 315 1*

\* = Fitting fabrikasi / hand made

## PVC CAP RR

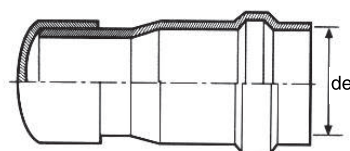
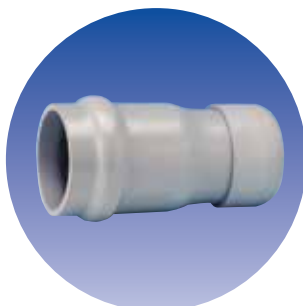

de (mm)	Kode Produk
63	01 501 063 1*
90	01 501 090 1*
110	01 501 110 1*
160	01 501 160 1*

\* = Fitting fabrikasi / hand made

## PVC TEE RR/FL

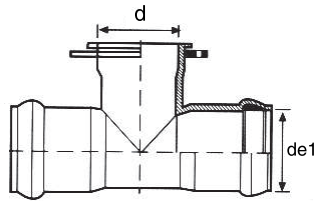

de <sub>1</sub> (mm)		d (DN)	Kode Produk
63	x	50	02 44 03 063 5
90	x	80	02 44 03 090 5
90	x	50	02 44 03 088 5
110	x	100	02 44 03 110 5
110	x	80	02 44 03 109 5
110	x	50	02 44 03 107 5
160	x	150	02 44 03 160 5
160	x	100	02 44 03 157 5
160	x	80	02 44 03 156 5
200	x	200	02 44 03 200 5
200	x	150	02 44 03 198 5
200	x	100	02 44 03 195 5
200	x	80	02 44 03 194 5
250	x	250	02 44 03 250 5
315	x	300	02 44 03 315 5
315	x	200	02 44 03 311 5
315	x	150	02 44 03 309 5
315	x	100	02 44 03 306 5

## PVC TEE RR

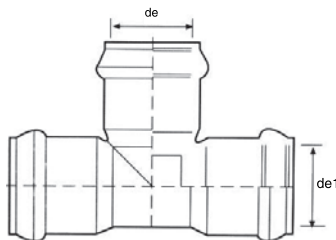

de <sub>1</sub> (mm)		de (mm)	Kode Produk
60	x	63	02 41 01 063 5
90	x	90	02 41 01 090 5
90	x	63	02 41 01 088 5
110	x	110	02 41 01 110 5
110	x	90	02 41 01 109 5
110	x	63	02 41 01 107 5
160	x	160	02 41 01 160 5
160	x	110	02 41 01 157 5
160	x	90	02 41 01 156 5
160	x	63	02 41 01 154 5
200	x	200	02 41 01 200 1*
200	x	160	02 41 01 198 1*
200	x	110	02 41 01 195 1*
200	x	90	02 41 01 194 1*
250	x	250	02 41 01 250 1*
250	x	200	02 41 21 250 1*
250	x	160	02 41 21 246 1*
250	x	110	02 41 21 243 1*
315	x	315	02 41 01 315 1*
315	x	250	02 41 01 311 1*
315	x	200	02 41 01 309 1*
315	x	160	02 41 01 306 1*
315	x	110	02 41 21 306 1*

\* = Fitting fabrikasi / hand made

## PVC SOCKET RR

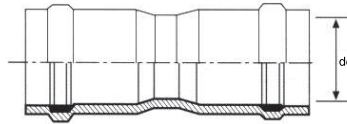
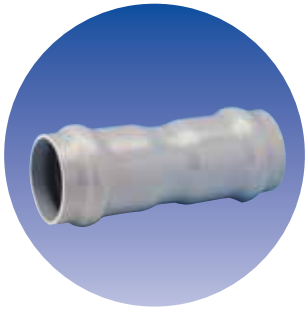

de (mm)	Kode Produk
63	01 11 01 063 1*
90	01 11 01 090 1*
110	01 11 01 110 1*
160	01 11 01 160 1*
200	01 11 01 200 1*
250	01 11 01 250 1*
315	01 11 01 315 1*
400	01 11 01 400 1*
500	01 11 01 500 1*

\* = Fitting fabrikasi / hand made

## PVC FLANGE SOCKET RR

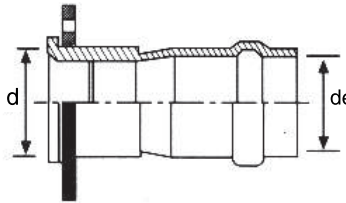

de (mm)	d (DN)	Kode Produk
63	x 50	01 11 13 063 1*
90	x 80	01 11 13 090 1*
110	x 100	01 11 13 100 1*
160	x 150	01 11 13 160 1*
200	x 200	01 11 13 200 1*
250	x 250	01 11 13 250 1*
315	x 300	01 11 13 315 1*

\* = Fitting fabrikasi / hand made

## PVC REPAIR SOCKET RR

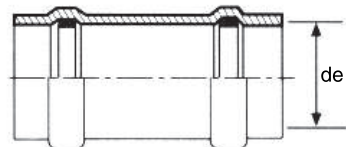

de (mm)	Kode Produk
63	01 11 03 063 1*
90	01 11 03 090 1*
110	01 11 03 110 1*
160	01 11 03 160 1*
200	01 11 03 200 1*
250	01 11 03 250 1*
315	01 11 03 315 1*
400	01 11 03 400 1*
500	01 11 03 500 1*

\* = Fitting fabrikasi / hand made

## Z-JOINT RING

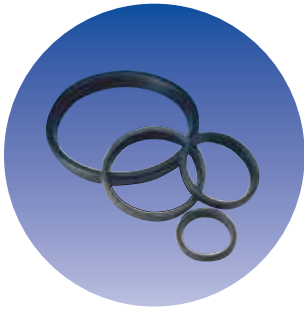

de (mm)	Kode Produk
63	006 00 063 9
90	006 00 090 9
110	006 00 110 9
160	006 00 160 9
200	006 00 200 9
250	006 00 250 9
315	006 00 315 9
400	006 00 400 9
500	006 00 500 9
630	006 00 630 9

## AKSESORIS

### FLANGE



DN	de (mm)	Jml. lubang x de lubang	Kode Produk
40	50	4 x 18	01 621 050 7
50	63	4 x 18	01 621 063 7
80	90	8 x 18	01 621 090 7
100	110	8 x 18	01 621 110 7
150	160	8 x 22	01 621 160 7
200	200	8 x 22	01 621 200 7
250	250	12 x 22	01 621 250 7
300	315	12 x 22	01 621 315 7

### BLIND FLANGE



DN	de (mm)	Jml. lubang x de lubang	Kode Produk
40	50	4 x 18	01 520 050 7
50	63	4 x 18	01 520 063 7
80	90	8 x 18	01 520 090 7
100	110	8 x 18	01 520 110 7
150	160	8 x 22	01 520 160 7
200	200	8 x 22	01 520 200 7
250	250	12 x 22	01 520 250 7
300	315	12 x 22	01 520 315 7

## LEM RUGLUE



Jenis	Isi/box
Lem Botol 60 gr	100
Lem Kaleng 400 gr	12
Lem Tube 40 gr	70
Lem Tube 50 gr	80

## BOLT NUT AND WASHER

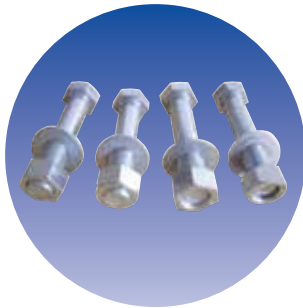

Ukuran Produk	Kode Produk
40	01 620 040 7
50	01 620 050 7
63	01 620 063 7
90	01 620 090 7
110	01 620 110 7
160	01 620 160 7
200	01 620 200 7
250	01 620 250 7
315	01 620 315 7

## LUBRICANT



Ukuran Produk	Kode Produk
800 gr	90 640 000 9

## Transportasi & Penyimpanan

### Lokasi Penyimpanan

Untuk lokasi penyimpanan dilapangan maupun di gudang perlu di perhatikan beberapa hal, yaitu :

- Harus rata dan memiliki level permukaan yang baik untuk meminimalisasi pergeseran.
- Bebas dari benda tajam yang akan merusak permukaan luar maupun dalam pipa.
- Disediakan ruang gerak untuk orang dan *forklift/pallet truck*, sehingga memudahkan dalam penanganan dan transportasi.
- Jauh dari sumber panas yang akan mengakibatkan deformasi.
- Jauh dari lokasi penyimpanan oli, lem maupun zat lain yang akan mengakibatkan kerusakan.



### Penanganan/Handling

Ketika RUCIKASAFE & RUCIKALOK akan dilakukan penanganan secara manual/individu, maka penanganan pipa harus dilakukan dengan hati-hati, jangan dilempar, dibanting maupun diseret.

2.

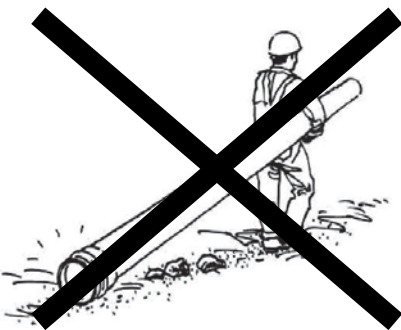

3.

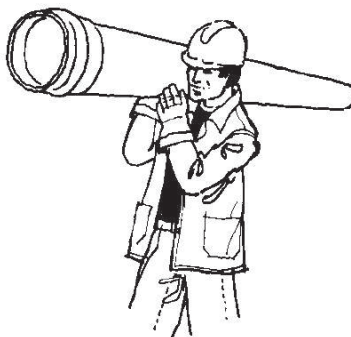

4.

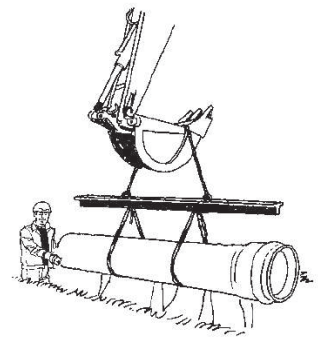

## Penyimpanan

5.

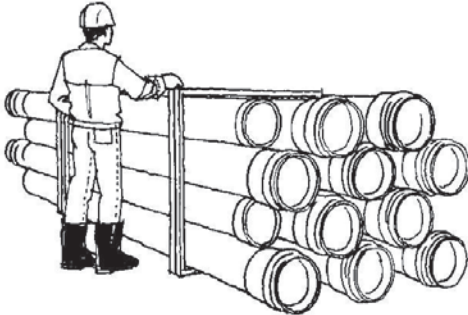

6.

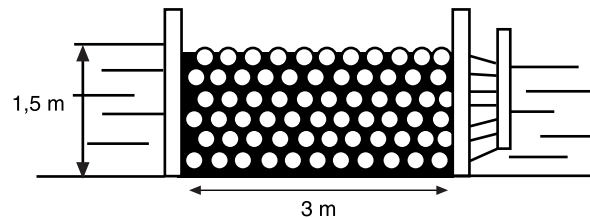

- Untuk mempermudah pengenalan maka sebaiknya penyusunan berdasarkan kelompok akan sangat membantu.
- Tinggi maksimum penyusunan adalah 1,5 meter dan lebar maksimum penyusunan adalah 3 meter (6).
- Sebagai penunjang landasan diberikan landasan dengan tinggi rata-rata 75 mm dengan jarak antara penyangga 1,5 meter.
- Sebagai penunjang samping untuk pengelompokan dan mencegah pergeseran pipa, maka dibuat penyangga yang kuat dengan tinggi + 2 meter dengan jarak antara penyangga 1,5 meter.
- Radiasi ultra-violet secara langsung dalam jangka waktu yang lama perlahan-lahan akan mempengaruhi kekuatan (*impact strength*) dari material uPVC sehingga mengurangi *life time*, untuk itu penyimpanan terbuka (*outdoor*) dalam jangka waktu yang lama perlu dilindungi dari radiasi langsung ultra violet.

7.



8.



- Untuk melindungi socket pipa maka penyusunan pipa biasanya dilakukan dengan memberikan sekat diantara pipa maupun dengan melakukan penyusunan sistem *back to back* (7) atau *crossing* / susun silang (8).

## Proses Penyambungan

### Proses Penyambungan RUCIKASAFE

1. Bersihkan kotoran pada permukaan spigot dan socket.
2. Ukur kedalaman socket dan beri tanda dengan spidol pada spigot.
3. Oleskan secukupnya lem pipa PVC pada permukaan *socket dilanjutkan dengan spigot*.
4. Sambungkan dengan segera dan posisi sambungan ditahan sesaat agar tidak berubah.
5. Bersihkan sisa kelebihan lem pipa PVC pada permukaan *spigot dan socket*.



### Proses Penyambungan RUCIKALOK

1. Berikan *chamfer* 15° pada ujung pipa spigot yang akan disambung.
2. Bersihkan kotoran pada permukaan spigot dan socket.
3. Ukur kedalaman socket dan beri tanda dengan spidol pada spigot.
4. Pasang ring karet pada alurnya dengan posisi lidah karet menghadap ke dalam.
5. Oleskan *lubricant* pada sekeliling bagian dalam ring karet Z-joint dan setengah panjang spigot yang telah diberi tanda spidol.
6. Posisikan pipa spigot dalam satu sumbu dengan ujung socket pipa atau fitting pasangannya kemudian dorong keduanya dengan gerakan perlahan dan memutar sampai tanda kedalaman spidol.



## Chemical Resistance

### Berdasarkan BS CP 312: Part 1: 1973

Chemical	Concentration	Unplasticized PVC		Chemical	Concentration	Unplasticized PVC	
		20°C	60°C			20°C	60°C
Acetaldehyde	40% soln.	S	U*	Ammonium hydrogen carbonate		S*	S*
	100%	U	U				
Acetic acid	10% soln.	S	S	Ammonium hydroxide, see ammonia solution			
	60%	S	D				
	glacial	U	U				
Acetic anhydride		U	U	Ammonium metaphosphate		S	S
Acetone		U	U	Ammonium nitrate		S	S
Acetonitrile			U*	Ammonium orthophosphates		S*	S*
Acetophenetidine		S*	S*				
Acetophenone		U*	U*	Ammonium oxalate		S*	S*
Adipic acid		S	D	Ammonium persulphate		S	S
Alcohols, see specific alcohols				Ammonium sulphate		S	S
				Ammonium sulphide		S	S
				Ammonium thiocyanate		S	S
Aliphatic hydrocarbons		S	S	Ammonium zinc chloride (zinc ammonium chloride)		S*	S*
Allyl alcohol		D	U				
Allyl chloride		U	U	Amyl acetate		U	U
Alum, see aluminium potassium sulphate							
Aluminium acetate		S*	S*	Amyl alcohol		S*	U
Aluminium chloride		S	S	Amyl chloride		U	U
Aluminium fluoride		S*	S*	Aniline		U	U
Aluminium hydroxide		S*	S*	Aniline hydrochloride		U	U
Aluminium nitrate		S	S	Aniline sulphate		U	U
Aluminium oxalate		S*	S*	Animal oils		S*	S*
Aluminium oxychloride		S	S	Anthraquinone		S	U
Aluminium potassium sulphate (alum)		S	S	Anthraquinone sulphonic acid		S	U
Aluminium sulphate		S	S	Antimony chloride		S	S*
Ammonia	dry gas	S	S	Aqua regia**	conc.	U	U
	liquid	U	U*	Aromatic hydrocarbons		U	U
Ammonia solution (ammonium hydroxide)	35% soln. (0.88 g/ml)	S	S	Arsenic acid (syrupy)	75% or 2 g/ml	S	D
Ammonium bicarbonate, see ammonium hydrogen carbonate				Aryl sulphonic acids		S	U
Ammonium carbonate		S	S	Barium carbonate		S*	S*
Ammonium chloride		S	S	Barium chloride		S*	S*
Ammonium ferrous citrate		S*	S*	Barium hydroxide		S	S
Ammonium fluoride		S	S	Barium sulphate		S*	S*
				Barium sulphide		S	S
				Beer		S	

## Chemical Resistance Berdasarkan BS CP 312: Part 1: 1973

Chemical	Concentration	Unplasticized PVC		Chemical	Concentration	Unplasticized PVC	
		20°C	60°C			20°C	60°C
Benzaldehyde	trace	U	U	Calcium orthophosphates		S*	S*
	100%	U	U	Calcium sulphate		S	S
Benzene		U	U	Calcium sulphide		S	S
Benzoic acid		D	U	Carbon dioxide (gas)		S	S
Benzoyl chloride		U*	U*	Carbon disulphide		U	
Benzyl acetate		U	U*	Carbon monoxide		S	S
Benzyl alcohol phenylcarbinol		U*	U*	Carbon tetrachloride		D	U
				Casein		S*	S*
Bismuth carbonate		S	S	Castor oil <sup>+</sup>		S	S
Borax, see disodium tetraborate				Cetyl alcohol, see hexadecanol			
Boric acid		S	S	Chloral hydrate		S	S
Boron trifluoride		S		Chloric acid		S	S**
Brine		S	S	Chlorine, gas	10% dry	D	
Bromine	trace	S	U		100% dry	D	U
	100% dry gas	U*	U		10% moist	U	U
	liquid	U	U	Chlorine	sat. aq. soln.	D	U*
Bromomethane (methyl bromide)		U*	U*	Chlorine trifluoride		U*	U*
				Chloroacetic acid		S	D
Butadiene		S	S	Chlorobenzene		U	U
Butane		S	S	Chloroethane (ethyl chloride)		U	U
Butanediols		U	U	2-Chloroethanol (ethylene chlorohydrin)		U	U
Butanols (butyl alcohols)		S	D				
Butyl acetate		U	U	Chloroform		U	U
Butyl chloride		U	U	Chloromethane (methyl chloride)		U	U
isoButyl methyl ketone (4-methylpentan-2-one)		U*	U*	Chlorosulphonic acid		D	U
Butylphenols		U	U	Chromic acid	plating soln.	S	S
Butyraldehyde		U*	U*	Chromic potassium sulphate (chrome alum)		S	S
Butyric acid	20% aq. soln.	S	U*				
	conc.	U	U	Cider <sup>+</sup>		S*	
Calcium carbonate		S	S	Citric acid <sup>+</sup>		S	S
Calcium chlorate		S	S	Copper** chloride		S*	S*
Calcium chloride	aq. soln.	S	S	Copper** cyanide		S*	S*
Calcium hydrogen sulphite (calcium bisulphite)		S*	S*	Copper** fluoride		S	S
				Copper** nitrate		S*	S*
				Copper** sulphate		S	S
Calcium hydroxide		S	S	Creosote		U	U
Calcium hypochlorite		S	S	Cresols		U	U
Calcium nitrate		S	S				

Chemical	Concentration	Unplasticized PVC		Chemical	Concentration	Unplasticized PVC	
		20°C	60°C			20°C	60°C
Cresylic acid		U	U*	Dodecanoic acid (lauric acid)		S	S
Crotonaldehyde		U	U	Dodecanol (lauryl alcohol)		S*	S*
Cyclohexanol		U	U				
Cyclohexanone		U	U	Emulsifiers	all	S*	S*
Decahydronaphtalene (decalin)				Emulsions (photographic)		S	S
Detergents (synthetic)	diluted for use	S	S*	Ethane		S*	
Developers (photographic)		S	S	Ethanediol (ethylene glycol)		S	S
Dextrin		S	S	Ethanol (ethyl alcohol)	95-100%	S	D
Dextrose	sat. soln.	S	S		40% aq. soln.	S	D
Diamyl ether		U*	U*	Ethers (see also diethyl ether)		U	U
Diazo salts		S	S	Ethyl acetate		U	U
Dibromoethane (ethylene dibromide)		U*	U*	Ethyl acrylate		U	U
Dibutyl phthalate		U*	U*	Ethyl alcohol, see ethanol			
Dichlorobenzene		U*	U*	Ethyl butyrate		U*	U*
Dichlorodifluoromethane		S		Ethyl chloride, see chloroethane			
Dichloroethane (ethylene dichloride)		U	U	Ethyl formate		U*	U*
Dichloroethylene		U*	U*	Ethyl lactate		U*	U*
1,2-Dichloropropane (propylene dichloride)		U	U	Ethyl methyl ketone (methyl ethyl ketone)		U	U
Diethyl ether		U	U	Ethyl sulphate, see diethyl sulphate			
Diethyl ketone		U*	U*	Ethylene chlorohydrin, see 2-chloroethanol			
Diethyl sulphate (ethyl sulphate)		U	U	Ethylene dibromide, see dibromoethane			
Digol (diethylene glycol)		S*	S*	Ethylene dichloride, see dichloroethane			
Dimethyl sulphate (methyl sulphate)		S	U	Ethylene glycol, see ethanediol			
Dimethylamine		S	S	Ethylene oxide (oxiran)		U	U
Dimethylearbinol, see isopropyl alcohol				Fatty acids, higher		S	S
Dioetyl phthalate		U*	U*	Ferric chloride		S	S
Dioxan		U*	U*	Ferric nitrate		S	S
Diphenyl ether		U	U	Ferric sulphate		S	S
Disodium phosphate, see disodium hydrogen orthophosphate							

## Chemical Resistance Berdasarkan BS CP 312: Part 1: 1973

Chemical	Concentration	Unplasticized PVC		Chemical	Concentration	Unplasticized PVC	
		20°C	60°C			20°C	60°C
Ferrous ammonium citrate, see ammonium ferrous citrate				Hydrochloric acid	22% aq. soln.	S	S
					concentrated (36%)	S	S
Ferrous chloride		S*	S*	Hydrocyanic acid	10% aq. soln.	S	S
Ferrous sulphate		S*	S*	Hydrofluoric acid	4% aq. soln.	S	S
Fixing soln. (photographic)		S	S		40% aq. soln.	S	U
Fluorine		U	U		60% aq. soln.	D	U
Fluorosilic acid	40% aq. soln.	S	S		concentrated	U*	U*
	conc.	S	S	Hydrogen		S	S
Formaldehyde	40% aq. soln.	S	S	Hydrogen bromide	anhydrous	S*	S*
Formic acid	3% aq. soln.	S	S	Hydrogen chloride	anhydrous	S*	S*
	10% aq. soln.	S	S	Hydrogen fluoride	anhydrous	S*	S*
	25% aq. soln.	S	D	Hydrogen peroxide	3% aq. soln.	S	S
	50% aq. soln.	S	U		12% aq. soln.	S	S
	98-100%	U	U		90% or greater	U	U
Fructose		S	S	Hydrogen sulphide		S	S
Fruit juices		S	S	Hydroquinone, see quinol			
Fuel oil		S	S	Hydroxylammonium sulphate		S	S
Furfuraldehyde (furfural)	100%	U	U	Hypochlorous acid		D	U*
Furfuryl alcohol		U*	U				
Gallic acid, see 3,4, 5-trihydroxybenzoic acid				Iodine	soln. in potassium iodide	U	U
Gasoline, see petrol				Iso-octane (2,2 4-trimethylpentane)		S	U
Glucose		S	S		Isophorone		U
Glycerol		S	S	Isopropanol, see isopropyl alcohol			
Glycerol monobenzyl ether		U*	U*				
Glycol, see ethanediol				Lactic acid	10% aq. soln.	S	S
Glycollic acid	30% alc. soln.	S	S		100%	U	U
Grape Sugar		S	S	Lanolin		S*	S*
Heptane		S	U		Latex		S
				Hexadecanol (etyl alcohol)		S*	S*
Hexanol (hexyl alcohol)		S	S	Lauryl alcohol, see dodecanol			
Hydrazine hydrate					Lead acetate		S
Hydrobromic acid	50% aq. soln.	S	S				
Hydrochloric acid	100% aq. soln.	S*	S*				
	10% aq. soln.	S	S				

Chemical	Concentration	Unplasticized PVC		Chemical	Concentration	Unplasticized PVC	
		20°C	60°C			20°C	60°C
Lead arsenate		S*	S*	Methyl hydrogen sulphate (methyl sulphuric acid)	50% aq. soln.	S	S
Lead nitrate		S*	S*		60% aq. soln.	S	S
Lead tetraethyl, see tetraethyl lead					75% aq. soln.	S	S
Linoleic acid		S	S		90% aq. soln.	S	S
Linseed oil		S	S	Methyl methacrylate		U	U
Lubricating oil		S	S	Methyl sulphate, see dimethyl sulphate			
Magnesium carbonate		S	S	Methylated spirits		S	D
Magnesium chloride		S	S	Methylcyclohexanone		U	U
Magnesium hydroxide		S	S	Methylsulphonic acid		S	D
Magnesium nitrate		S	S	Milk		S*	S*
Maleic acid	25% aq. soln.	S	S	Mineral oils		S	S
	50% aq. soln.	S	S	Mixed acids**			U
	concentrated	S	S	Molasses		S	S
Malic acid		S	S	Monochlorobenzene		U*	U*
Manganese sulphate		S*	S*				
Margarine		S	S	Naphtha		S	S
Mercuric chloride		S	S	Naphthalene		U	U
Mercuric cyanide		S	S	Nickel chloride		S	S
Mercurous nitrate		S	S	Nickel nitrate		S	S
Mercury		S	S	Nickel sulphate		S	S
Mesityl oxide		U	U	Nicotine		S	S
Metallic soaps (water soluble)		S*	S*	Nicotinic acid		S	S
Methanol (methyl alcohol)	100%	S	D	Nitric acid	5% aq. soln.	S	
	6% aq. soln.	S	S*		10% aq. soln.	S	D
Methoxybutanol					25% aq. soln.	S	D
Methyl acetate		U*	U*		50% aq. soln.	S	U
Methyl bromide see bromomethane					70% aq. soln.	D	U
					98% aq. soln.	U	U
Methyl <i>isobutyl</i> ketone, see <i>isobutyl methyl</i> ketone				Nitrobenzene		U	U
Methyl chloride, see chloromethane				Nitropropane		U	U
				Nitrous fumes	moist	D	U
Methyl ethyl ketone, see ethyl methyl ketone				Nonanol (nonyl alcohol)		S*	S*
Methyl glycol		S	S				
				Octane		S*	U*
				Octanol (octyl alcohol)		S*	
				Octylcresol			
				Oils and fats		S	S
				Oleic acid		S	S

## Chemical Resistance Berdasarkan BS CP 312: Part 1: 1973

Chemical	Concentration	Unplasticized PVC		Chemical	Concentration	Unplasticized PVC	
		20°C	60°C			20°C	60°C
Orthophosphoric acid	20% aq. soln.	S	S	Phthalic anhydride		S*	S*
	30% aq. soln.	S	S	Picric acid	1% aq. soln.	S	S*
	50% aq. soln.	S	S		10% alc. soln.	U	U
	95% aq. soln.	S	S	Plating solutions:			
Oxalic acid		S	S	brass		S	S
Oxygen		S	S	cadmium		S	S
Ozone		S	S	chromium		S	S
				copper		S	S
Palmitic acid	10%	S	S	gold		S	S
	70%	S	S	indium		S	S
Paraffin		S	S	lead		S	S
Paraffin wax		S	S	nickel		S	S
Pentane		S*		rhodium		S	S
Perchloric acid	10%	S	D	silver		S	S
Petrol		S	U	tin		S	S
Petrol/benzene mixture	80:20 ratio	U	U	zinc		S	S
Petroleum spirit (petroleum ether)		U	U	Polyglycol ethers		U*	U*
Phenol		S	U	Potassium acid sulphate, see potassium hydrogen sulphate			
Phenylcarbinol, see benzyl alcohol				Potassium antimonate		S*	S*
Phenylhydrazine		U	U	Potassium bicarbonate, see potassium hydrogen carbonate			
Phenylhydrazine hydrochloride		U	U	Potassium bichromate, see potassium dichromate			
Phosgene	gas	S	U	Potassium bisulphate, see potassium hydrogen sulphite			
	liquid	U	U	Potassium borate		S	S
Phosphates (see also under ammonium, potassium, sodium, etc.)		S*	S*	Potassium bromate		S	S
Phosphine		S	S	Potassium bromide		S	S
Phosphoric acid, see orthophosphoric acid				Potassium carbonate		S	S
				Potassium chlorate		S	S
				Potassium chloride		S	S
Phosphorus		S	U	Potassium chromate		S	S
Phosphorus pentoxide		S	S*	Potassium cuprocyanide		S*	S*
Phosphorus trichloride		U	U	Potassium cyanide		S	S
Phosphoryl chloride (phosphorus oxychloride)		U	U				

Chemical	Concentration	Unplasticized PVC		Chemical	Concentration	Unplasticized PVC	
		20°C	60°C			20°C	60°C
Potassium dichromate (potassium bichromate)		S	S	Quinol (hydroquinone)		S*	S*
Potassium ferricyanide		S	S	Rayon coagulating bath		S*	S*
Potassium ferrocyanide		S	S				
Potassium fluoride				Saccharose <sup>+</sup>		S*	S*
Potassium hydrogen carbonate (potassium bicarbonate)		S	S	Salicylic acid		S	S
				Sea water		S	S
				Selenic acid		U	U
Potassium hydrogen sulphate (potassium acid sulphate)		S	S*	Shortening		S*	S*
				Silicone fluids			
				Silicic acid		S	S
Potassium hydrogen sulphite (potassium bisulphite)		S*	S*	Silver acetate		S*	S*
				Silver cyanide		S	S
				Silver nitrate		S	S
Potassium hydroxide	1% aq. soln.	S	S	Soap solutions (aqueous)		S	S
	10% aq. soln.	S	S	Sodium acetate		S	S
	conc. soln.	S	S	Sodium acid sulphate, see sodium hydrogen sulphate			
Potassium hypochlorite	S*	S*					
Potassium nitrate	S	S					
Potassium orthophosphates		S*	S*	Sodium aluminate		S*	S*
Potassium perborate		S	S	Sodium antimonate		S*	S*
Potassium perchlorate	10% soln.	S	S	Sodium benzoate		S	D
Potassium permanganate	20% soln.	S	S	Sodium bicarbonate, see sodium hydrogen carbonate			
Potassium persulphate	5% soln.	S	S				
Potassium sulphate		S	S				
Potassium sulphide		S*	S*	Sodium bisulphate, see sodium hydrogen sulphite			
Potassium thiosulphate		S*	S*				
Propane		S	S				
Propane-1, 2-diol (propylene glycol)		S*	S*	Sodium bisulphite, see sodium hydrogen sulphite			
Propargyl alcohol (prop-2-yn-1-ol)		S	S				
Propionic acid	50% aq. soln.	S*	S*	Sodium borate, see sodium tetraborate			
	100% aq. soln.	S*	U*				
<i>iso</i> Propyl alcohol (isopropanol)		S	S	Sodium bromide		S	S
				Sodium carbonate		S	S
				Sodium chlorate		S	S
Propylene dichloride, see 1, 2-dichloropropane				Sodium chloride		S	S
				Sodium cyanide		S*	S*
Propylene oxide		U*	U*	Sodium ferricyanide		S	S
Pyridine		U	U	Sodium ferrocyanide		S	S

## Chemical Resistance Berdasarkan BS CP 312: Part 1: 1973

Chemical	Concentration	Unplasticized PVC		Chemical	Concentration	Unplasticized PVC	
		20°C	60°C			20°C	60°C
Sodium fluoride		S	S	Sulphur dioxide	liquid	D	U
Sodium hydrogen carbonate (sodium bicarbonate)		S	S	Sulphur trioxide		S	S
<i>di</i> Sodium hydrogen orthophosphate		S*	S*	Sulphuric acid	10% aq. soln.	S	S
Sodium hydrogen sulphate (sodium bisulphate)		S	S		20% aq. soln.	S	S
Sodium hydrogen sulphite (sodium bisulphate)		S	S		30% aq. soln.	S	S
Sodium hydroxide	1% aq. soln.	S	S		40% aq. soln.	S	S
	10% aq. soln.	S	S		50% aq. soln.	S	S
	40% aq. soln.	S	S		55% aq. soln.	S	S
	conc.	S	S		60% aq. soln.	S	S
Sodium hypochlorite	15% available chlorine	S	S		70% aq. soln.	S	S
					80% aq. soln.	S	S
Sodium hyposulphite, see sodium thiosulphate					90% aq. soln.	D	D
Sodium metaphosphate		S*	S*		95% aq. soln.	D	U
Sodium nitrate		S	S	98% aq. soln.	U	U	
Sodium nitrite		S	S	fuming	U*	U*	
<i>tri</i> Sodium orthophosphate		S*	S*	Sulphurous acid	10% aq. soln.	S	S
Sodium perborate		S*	S*		30% aq. soln.	S	S
Sodium peroxide		S*	S*	Surface active agents	all	S*	S*
Sodium silicate		S*	S*				
Sodium sulphate		S	S	Tallow		S*	S*
Sodium sulphide	aq. soln.	S	S	Tannic acid		S	S
<i>di</i> Sodium tetraborate (borax)		S	S	Tanning extracts		S	S*
Sodium thiosulphate (sodium hyposulphite)		S*	S*	Tartaric acid <sup>+</sup>		S	S
Soft soap		S*	S*	Tetraethyl lead (lead tetraethyl)		S	S
Stannic chloride		S	S	Tetrahydrofuran		U	U
Stannous chloride		S	S	Tetrahydronaphthalene (tetralin)		U	U
Starch		S	S	Thionyl chloride		U	U
Stearic acid		S	S	Titanium tetrachloride		U	U
Sucrose		S*	S*	Toluene		U	U
Sulphur	colloidal	S	S	Transformer oil		S*	S*
Sulphur dioxide	dry	S	S	Tributyl phosphate		U	U
	moist	S	U	Trichloroacetic acid		S*	S*
				Trichlorobenzene		U*	U*
				Trichloroethane		U*	U*
				Trichloroethylene		U	U
				Tricresyl phosphate, see tritolyl phosphate			
				Triethanolamine		S	U

Chemical	Concentration	Unplasticized PVC		Chemical	Concentration	Unplasticized PVC	
		20°C	60°C			20°C	60°C
Trigol (triethylene glycold)		S*	S*	Vinegar		S	S
3, 4, 5-Trihydroxybenzoic acid (gallic acid)		S*	S*	Vinyl acetate		U	U
Trimethylamine		S	U*	Water		S	S
Trimethylol propane (2-ethyl-hydroxy-methylpropanediol)		S	U	Wetting agents		S*	S*
				Whey		S*	S*
				Wines and spirits		S	S
Trisodium phosphate, see sodium orthophosphate				Xylene		U*	U*
				Xylenol		U*	U*E
				Yeast		S	S
Tritolyl phosphate (tricresylphosphate)		U*	U*	Zinc ammonium chloride, see ammonium zinc chloride			
Turpentine		S	S	Zinc carbonate		S*	S*
Urea		S	S	Zinc chloride		S	S
Urine		S	S	Zinc oxide		S	S
Vanilla extract		S*	S*	Zinc sulphate		S	S
Vegetable oils		S	S				

**Keterangan:**

S : Satisfaction

U : Unsatisfaction

D : Some attack or absorption

E : Environmental stress cracking hazard

\* : Predicted results

## Referensi Proyek

NO.	PROYEK	TAHUN
01.	SUPPLY OF TRANSMISSION AND DISTRIBUTION PIPE AND FITTINGS DIA 63 MM TO DIA 400 MM (WS - 3 / 3.1) PDAM TIRTANADI PROPINSI SUMATERA UTARA SEKTOR AIR BERSIH METROPOLITAN MEDAN URBAN DEVELOPMENT PROJECT	TAHUN 2003
02.	PENANGGULANGAN DAMPAK PENGURANGAN SUBSIDI ENERGI UNTUK PENYEDIAAN AIR BERSIH KABUPATEN TANGERANG APBD SEAB TAHUN ANGGARAN 2003 DINAS LINGKUNGAN HIDUP KABUPATEN TANGERANG	TAHUN 2003
03.	PENGADAAN PIPA DAN ACCESSORIES PVC UNTUK JARINGAN AIR MINUM PDAM TIRTA MUSI PALEMBANG	TAHUN 2003
04.	PENGADAAN PIPA DAN ACCESSORIES PVC UNTUK PDAM TIRTA MUSI PALEMBANG - APBD SEAB PROJECT KOTA PALEMBANG T.A. 2004	TAHUN 2004
05.	PENGADAAN PIPA DAN ACCESSORIES PVC UNTUK AIR LIMBAH PDAM KOTA BANDUNG	TAHUN 2005
06.	PENGADAAN PIPA DAN ACCESSORIES PVC UNTUK PDAM KOTA BANDUNG	TAHUN 2005
07.	PENGADAAN PIPA DAN ACCESSORIES PVC UNTUK JARINGAN DISTRIBUSI PROCUREMENT OF PIPE AND ACCESSORIES FOR DISTRIBUTION AND DAN RETIKULASI KOTA BOGOR OLEH PDAM TIRTA PAKUAN KOTA BOGOR	TAHUN 2005
08.	PENGADAAN PIPA DAN ACCESSORIES PVC UNTUK PIPA DISTRIBUSI AIR BERSIH KPS KOTA DEPOK JAWA BARAT	TAHUN 2006
09.	PENGADAAN PIPA PVC PDAM KOTA CIREBON	TAHUN 2006
10.	PENGADAAN PIPA DAN PERLENGKAPANNYA SWASH PROJECT PROP. SULAWESI SELATAN DAN GORONTALO	TAHUN 2006
11.	PENGADAAN PIPA PVC DAN ACCESSORIES DINAS KIMPRASWIL DAN PERTAMBANGAN KAB. MALAWI - KALIMANTAN BARAT	TAHUN 2006
12.	PENGADAAN PIPA DAN ACCESSORIES SISTEM PENYEDIAAN AIR BERSIH KEC. LHOKNGA KAB. ACEH BESAR	TAHUN 2006
13.	PENGADAAN PIPA TRANSMISI DAN DISTRIBUSI RANTAU PANJANG PDAM TIRTA MEULABOH KAB. ACEH BARAT DAN PDAM TIRTANADI CAB. TELUK DALAM KAB. NIAS SELATAN	TAHUN 2006
14.	PENGADAAN JARINGAN PIPA TRANSMISI INTAKE DAN DISTRIBUSI KE WTP & PDAM TIRTA MEULABOH KAB. ACEH BARAT DAN KAB. SIMEULUE PROGRAM SAB-SAS STICHTING H2O PARTNERS FOR NORTHERN SUMATERA	TAHUN 2007



PDAM Bogor



Kota Delta Mas - Karawang



Kota Legenda - Cibubur



Kawasan Industri Jababeka  
Cikarang



Kota Wisata - Cibubur



WTP Citra Garden - Cengkareng



Citra Grand - Cibubur



PDAM Bekasi

**RUCIKA**

**SAFE & LOK**



**PT. PIPA LAKU INDONESIA**

**PLI PIPALAKU**  
Distributor Pipa & Accessories

Ruko Neo Arcade Blok B No. 3 - Gading Serpong - kelapa Dua  
Tangerang - Banten - Indonesia - 021 22223993

[www.pipalaku.com](http://www.pipalaku.com)